

TRIPOD 1 FLOOR 500L

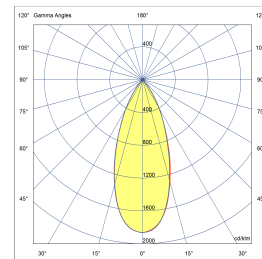

POWERLED(S)	2 x 5 Watt incl.	ADJUSTABILITY	360°
CRI	90+	VOLTAGE	230 VAC - 50/60 Hz
GEAR / DRIVER	230 VAC LED	MATERIAL	Aluminium
WEIGHT	1,1 KG	IP	65

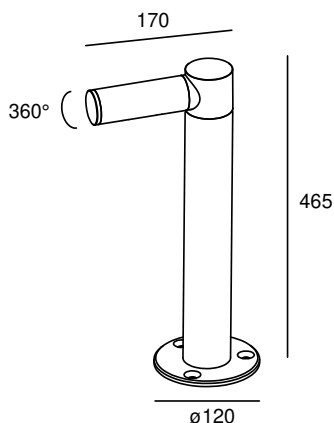

SPECIAL: Other finishing on request, real brons, real stainless steel 316L EL

MODELS

	ARTICLE N°	DESCRIPTION	COLOUR	KELVIN	LUMEN
	012112522702	TRIPOD 1 WALL EXT. WARM WHITE	BLACK STRUC.	2700	x
	012112523002	TRIPOD 1 WALL EXT. WARM WHITE	BLACK STRUC.	3000	x
	012112524002	TRIPOD 1 WALL EXT. NATURAL WHITE	BLACK STRUC.	4000	x
	012112522715	TRIPOD 1 WALL EXT. WARM WHITE	GREY STRUC.	2700	x
	012112523015	TRIPOD 1 WALL EXT. WARM WHITE	GREY STRUC.	3000	x
	012112524015	TRIPOD 1 WALL EXT. NATURAL WHITE	GREY STRUC.	4000	x
	012112522703	TRIPOD 1 WALL EXT. WARM WHITE	ANY RAL	2700	x
	012112523003	TRIPOD 1 WALL EXT. WARM WHITE	ANY RAL	3000	x
	012112524003	TRIPOD 1 WALL EXT. NATURAL WHITE	ANY RAL	4000	x